



The Leading Enterprise Internet of Things Solution

ALTA Accelerometer - G-Force Max/Avg Sensor

General Description

The RF Wireless Accelerometer is a digital, low power, low profile, capacitive sensor that is able to measure acceleration on three axes. Four different accelerometer types are available from Monnit.



Free iMonnit basic online wireless sensor monitoring and notification system to configure sensors, view data and set alerts via SMS text and email.

Principle of Operation

The Wireless Accelerometer - G-Force Max/Avg sensor employs a MEMS (micro electromechanical system) based accelerometer sensor system to detect forces caused by acceleration. These forces may be static such as the constant force of gravity pulling at one's feet, or they could be dynamic - caused by moving or vibrating the accelerometer. A user may set thresholds (defined as Delta Values in the user interface) for each axis (X, Y, Z) as well as a magnitude threshold, such that when thresholds are exceeded the sensor will trigger and report data to iMonnit immediately. The solution consists of one accelerometer with multiple modes which allow for increased detection range (2g, 4g, 8g). There is a small loss of resolution when in 4g and 8g mode but a 2x and 4x increase in force detection range, respectively. Additionally, the accelerometer can be put in a high pass filter (HPF) mode where it will filter out static acceleration effects such as the effect of gravity. This HPF mode is user configurable for each 2g, 4g, and 8g modes. Another user configurable mode for the sensor is the output data rate (ODR). This rate controls how quickly the sensor will take data samples, effectively setting how quickly the sensor can trigger after passing a user set threshold. A higher ODR (such as 100 Hz) will trigger in under a second, where as a lower ODR (such as 6 Hz) will take up to 5 seconds to trigger. It should be noted that a higher ODR results in a decreased battery lifetime. A user may also set a re-arm time, which establishes the time after the sensor triggers before the sensor may trigger again.

Example Applications

- Unauthorized access via a fence breach
- Physical barrier integrity
- Abnormal motor shake
- Wind turbine abnormalities
- Assembly line irregularities
- And many more...

Features of Monnit ALTA Sensors

- Wireless range of 1,200+ feet through 12+ walls *
- Frequency-Hopping Spread Spectrum (FHSS)
- Improved interference immunity
- Improved power management for longer battery life ** (12+ years on AA batteries)
- Encrypt-RF® Security (Diffie-Hellman Key Exchange + AES-128 CBC for sensor data messages)
- All ALTA sensors now have up to 3200 readings:
 - 10-minute heartbeats = 22 days
 - 2-hour heartbeats = 266 days
- Over-the-air updates (future proof)
- Free iMonnit basic online wireless sensor monitoring and notification system to configure sensors, view data and set alerts via SMS text and email

* Actual range may vary depending on environment.

** Battery life is determined by sensor reporting frequency and other variables. Other power options are also available.

Wireless Range Comparison

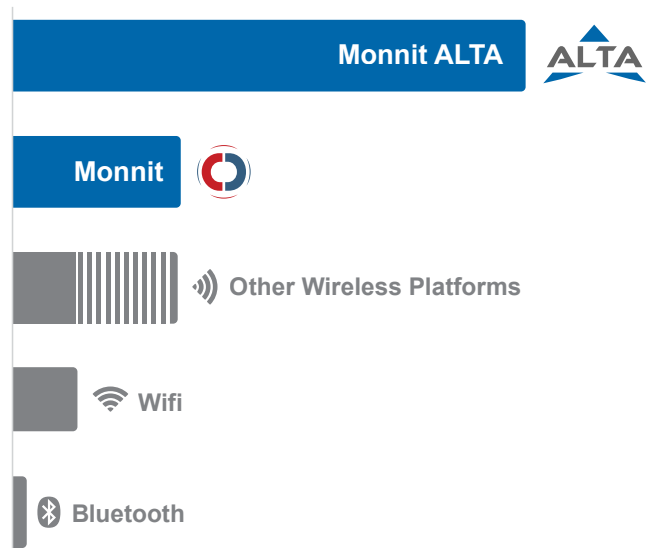

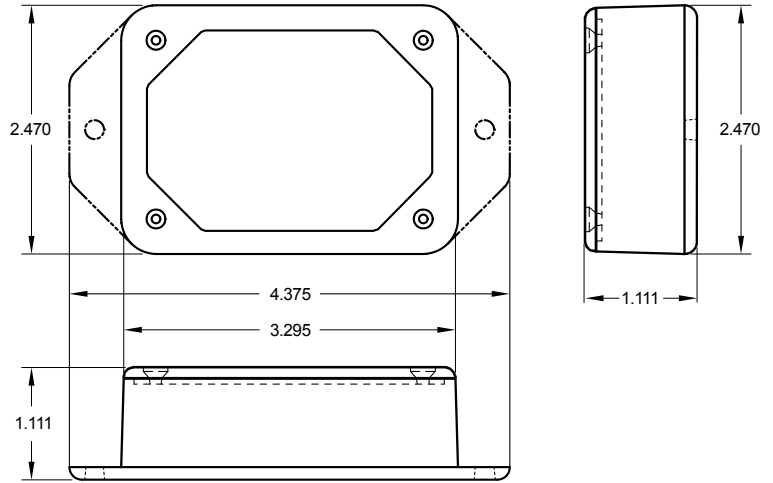

ALTA Commercial AA Wireless Accelerometer - G-Force Max/Avg | Technical Specifications

| | | | | |
|---|--|---------|---------|----------|
| Supply Voltage | 2.0–3.8 VDC (3.0–3.8 VDC using power supply) * | | | |
| Current consumption | 6 Hz - 32.4 uA: ~ 4 year lifetime at two hour heartbeat. 12 Hz - 36.2 uA: ~ 4 year lifetime at two hour heartbeat. 50 Hz - 66.5 uA: ~ 2 year lifetime at two hour heartbeat. 100 Hz - 125.6 uA: ~ 1 year lifetime at two hour heartbeat. | | | |
| Accelerometer Current Consumption (Based on Output Data Rate) | 6 Hz | 12 Hz | 50 Hz | 100 Hz |
| | 32.4 uA | 36.2 uA | 66.5 uA | 125.6 uA |
| Operating temperature range (board circuitry and batteries) | -18°C to 55°C (0°F to 130°F) using alkaline -40°C to 85°C (-40°F to 185°F) using lithium ** | | | |
| Optimal battery temperature range (AA) | +10°C to +50°C (+50°F to +122°F) | | | |
| Sensitivity | 4096 count/g | | | |
| Sensitivity range selections | 2 G, 4 G, 8 G | | | |
| Measurement accuracy | 2.5 % (force: X, Y, Z) | | | |
| Minimum g-force to turn on/wake up | 0.050–0.100 g | | | |
| Output Data Rate (User Configurable) | 6 Hz, 12 Hz, 50 Hz, 100 Hz | | | |
| Integrated memory | Up to 3200 sensor messages | | | |
| Wireless range | 1,200+ ft non-line-of-sight | | | |
| Security | Encrypt-RF® (256-bit key exchange and AES-128 CTR) | | | |
| Weight | 3.7 ounces | | | |
| Certifications |  900 MHz product; FCC ID: ZTL-G2SC1 and IC: 9794A-G2SC1. 868 and 433 MHz product tested and found to comply with: EN 300 220-2 V3.1.1 (2017-02), EN 300 220-2 V3.1.1 (2017-02) and EN 60950 | | | |

* Hardware cannot withstand negative voltage. Please take care when connecting a power device.

** Light present 25% of day yields 125% of operating power to support 10-minute heartbeats.

Power Options

The standard version of this sensor is powered by two replaceable 1.5 V AA sized batteries (included with purchase). This sensor is also available with a line power option. The line powered version of this sensor has a barrel power connector allowing it to be powered by a standard 3.0–3.6 V power supply. The line powered version also uses two standard 1.5 V AA batteries as backup for uninterrupted operation in the event of line power outage. Power options must be selected at time of purchase, as the internal hardware of the sensor must be changed to support the selected power requirements.

Monnit Wireless Accelerometer Orientation (Commercial AA)

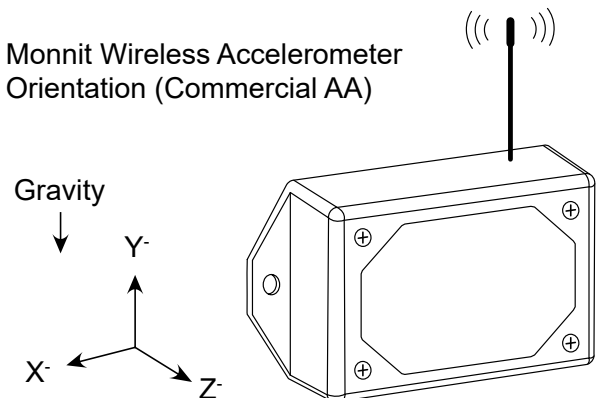



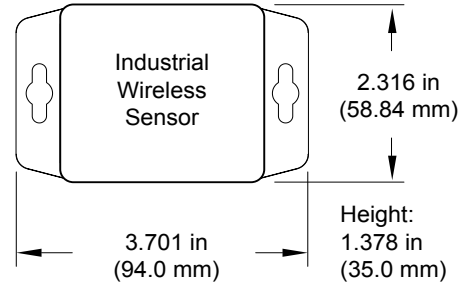
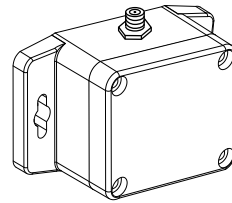
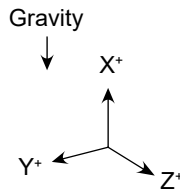

Monnit Wireless Accelerometer Orientation (Industrial)



ALTA Industrial Wireless Accelerometer - G-Force Max/Avg | Technical Specifications

| | | | | |
|---|---|--|---------|----------|
| Supply Voltage | 2.0–3.8 VDC (3.0–3.8 VDC using power supply) * | | | |
| Current consumption | 6 Hz - 32.4 uA: ~ 4 year lifetime at two hour heartbeat. 12 Hz - 36.2 uA: ~ 4 year lifetime at two hour heartbeat. 50 Hz - 66.5 uA: ~ 2 year lifetime at two hour heartbeat. 100 Hz - 125.6 uA: ~ 1 year lifetime at two hour heartbeat. | | | |
| Accelerometer Current Consumption (Based on Output Data Rate) | 6 Hz | 12 Hz | 50 Hz | 100 Hz |
| | 32.4 uA | 36.2 uA | 66.5 uA | 125.6 uA |
| Operating temperature range (board circuitry and battery) | -40°C to +85°C (-40°F to +185°F) ** | | | |
| Included battery | Max temperature range | -40° to +85°C (-40° to +185°F) | | |
| | Capacity | 1500 mAh | | |
| Sensitivity | 4096 count/g | | | |
| Sensitivity range selections | 2 G, 4 G, 8 G | | | |
| Measurement accuracy | 2.5 % (force: X, Y, Z) | | | |
| Minimum g-force to turn on/wake up | 0.050–0.100 g | | | |
| Output Data Rate (User Configurable) | 6 Hz, 12 Hz, 50 Hz, 100 Hz | | | |
| Integrated memory | Up to 3200 sensor messages | | | |
| Wireless range | 1,200+ ft non-line-of-sight | | | |
| Security | Encrypt-RF® (256-bit key exchange and AES-128 CTR) | | | |
| Weight | 4.7 ounces | | | |
| Enclosure rating | NEMA 1, 2, 4, 4x, 12 and 13 rated, sealed and weather proof | | | |
| UL rating | UL Listed to UL508-4x specifications (File E194432) | | | |
| Certifications |    | 900 MHz product; FCC ID: ZTL-G2SC1 and IC: 9794A-G2SC1. 868 and 433 MHz product tested and found to comply with: EN 300 220-2 V3.1.1 (2017-02), EN 300 220-2 V3.1.1 (2017-02) and EN 60950 | | |

* Hardware cannot withstand negative voltage. Please take care when connecting a power device.

** At temperatures above 100°C, it is possible for the board circuitry to lose programmed memory.

*** Light present 25% of day yields 125% of operating power to support 10-minute heartbeats.

Commercial Grade Sensors

Monnit commercial grade sensors are designed for applications in ordinary environments (normal room temperature, humidity and atmospheric pressure). Do not use these sensors under the following conditions as these factors can deteriorate the product characteristics and cause failures and burnout.

- Corrosive gas or deoxidizing gas: chlorine gas, hydrogen sulfide gas, ammonia gas, sulfuric acid gas, nitric oxides gas, etc.
- Volatile or flammable gas
- Dusty conditions
- Low-pressure or high-pressure environments
- Wet or excessively humid locations
- Places with salt water, oils chemical liquids or organic solvents
- Where there are excessively strong vibrations
- Other places where similar hazardous conditions exist

Use these products within the specified temperature range. Higher temperature may cause deterioration of the characteristics or the material quality.

Industrial Grade Sensors | Type 1, 2, 4, 4X, 12 and 13 NEMA Rated Enclosure

Monnit's Industrial sensors are enclosed in reliable, weatherproof NEMA-rated enclosures. Our NEMA-rated enclosures are constructed for both indoor or outdoor use and protect the sensor circuitry against the ingress of solid foreign objects like dust as well as the damaging effects of water (rain, sleet, snow, splashing water, and hose-directed water).

- Safe from falling dirt
- Protects against wind-blown dust
- Protects against rain, sleet, snow, splashing water, and hose-directed water
- Increased level of corrosion resistance
- Will remain undamaged by ice formation on the enclosure



For more information about our products or to place an order, please contact our sales department at 801-561-5555.

Visit us on the web at www.monnit.com.

Monnit Corporation
3400 South West Temple
Salt Lake City, UT 84115
801-561-5555
www.monnit.com